

Fitting instructions
Montageanleitung
Notice de montage
Istruzioni di montaggio
Montagehandleiding

Side Steps
Trittbrettkit
Marchepieds
Gradini laterali
Treeplankset

Skoda Kodiaq 2017>



PN: 0553005

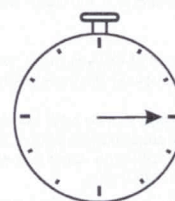

30 Min. (2 pieces)

GB

Read this mounting manual carefully, before you start the installation. Warranty is granted only when installation is done by your dealer. Modification related to design, construction, illustrations and text are reserved. It is possible that the handling characteristics of the vehicle may be influenced after fitting this product.

D

Bitte sehen Sie diese Einbau-Anleitung gründlich durch bevor Sie mit der Montage anfangen. Garantie wird nur gewährt wenn der Anbau von einem Händler ausgeführt worden ist. Änderungen hinsichtlich Ausstattung, Konstruktion, Abbildungen und Text Vorbehalten. Es ist möglich, dass sich die Fahrzeugcharakteristik nach Montage dieses Produktes verändert.

F

Lisez cette notice de montage soigneusement avant l'installation. Une garantie est seulement délivrée si l'installation a été exécuté par un commerçant. Sous réserve de modifications de projet, construction, illustrations et texte. Il est possible, qu'après montage de ce produit, les caractéristiques du véhicule en soient influencées.

NL

Lees deze montagehandleiding door alvorens u tot installatie overgaat. Garantie wordt alleen verleend indien de installatie is uitgevoerd door een erkende dealer. Veranderingen ten aanzien van ontwerp, constructie, afbeelding en tekst voorbehouden. Het is mogelijk dat de rijeigenschappen van het voertuig kunnen worden beïnvloed na montage van dit product.

I

Leggere attentamente questo manuale di istruzioni prima di iniziare il montaggio. La garanzia è valida solo se il montaggio viene effettuato dal concessionario. Il design, la costruzione, le figure e il testo possono essere soggetti a modifica. Le caratteristiche di uso possono essere influenzate dal montaggio del prodotto.

GB ATTENTION

Important notice! Guarantee claims/compensation claims of all kinds can only be entertained by us if assembly has been carried out properly and in accordance with instructions in a specialist workshop.

We would expressly point out that any improper assembly which is not carried out in a specialist workshop will result in the renunciation of the reinforcement of compensation claims of any kind, in particular those arising by virtue of the product liability law.

The type no: 0553005

is constructed for the above vehicle and can only be mounted on said vehicle. For the purpose of fixing, please use the attached fixing parts only.

The manufacturer accepts no liability whatsoever for damage or injury resulting from the use of these parts/accessories with the exception of product liability as referred to in articles 6:185 up to and including 6:192 of the Dutch Civil Code.

**D ACHTUNG**

Achtung! Etwaige Gewährleistungsansprüche bzw. Schadenersatzansprüche aller Art können von uns nur bei einer ordnungsgemäßen und der Anleitung entsprechenden Montage in einer Fachwerkstatt berücksichtigt werden.

Wir weisen ausdrücklich darauf hin, dass eine unsachgemäße und nicht in ein Fachwerkstatt durchgeführte Montage einen Verzicht auf dem Titel des Produkthaftpflichtrechtes bewirkt.

Die Typ-Nr 0553005

ist für das oben angeführte Fahrzeug konstruiert und darf nur auf diesem Fahrzeug montiert werden.

Für die Befestigung sind ausschließlich die beiliegenden Befestigungsteile zu verwenden.

Der Hersteller lehnt jede Haftung für Schäden oder Verletzungen, die aus der Nutzung dieser Teile / Zubehör entstehen können, mit Ausnahme der Haftung für Produkte, die in den Artikeln 6:185 bis einschließlich 6:192 des niederländischen Bürgerlichen Gesetzbuchs aufgeführt sind, ab.

F ATTENTION

Nous attirons votre attention sur le fait toute réclamation ou demande en dommage et intérêt ne pourrait être formulée que tant que le montage aura été fait suivant les instructions techniques prévues pour notre produit.

Il est expressément prévu qu'on ne saurait se prévaloir d'un quelconque préjudice contractuel ou réhibitoire si le montage avait été fait en dépit équipements adéquats.

Le type-nr 0553005

est construit pour le véhicule indiqué ci-dessus et ne peut être monter que sur ce véhicule. Pour la fixation, utiliser exclusivement les éléments ci-joints

Le constructeur exclut toute responsabilité pour les dommages ou blessures découlant de l'utilisation de ces pièces/accessoires, à l'exception de la responsabilité pour les produits, telle que visée aux articles du Code civil néerlandais allant de 6:185 à 6:192 inclus.

NL ATTENTIE

Attentie! Een claim op garantie, resp. Op schadeloosstelling van welke aard ook kan door ons slechts worden gehonoreerd indien ons product deskundig en overeenkomstig de voorschriften door een vakkundige werkplaats gemonteerd is. Wij wijzen er met nadruk op dat ondeskundige en niet door een vakkundige werkplaats uitgevoerde montage tot gevolg heeft dat daardoor ieder recht op schadevergoeding, ook op wettelijke aansprakelijkheid inzake producten vervalt.

Type-nr 0553005

is voor het bovengenoemde voertuig geconstrueerd en mag alleen op dit voertuig gemonteerd worden.

Voor de bevestiging behoren uitsluitend de bijliggende bevestigingsdelen gebruikt te worden.

De fabrikant sluit iedere aansprakelijkheid voor schade of letsel ten gevolge van het gebruik van deze onderdelen/accessoires uit, met uitzondering van aansprakelijkheid voor producten zoals bedoeld in de artikelen 6:185 tot en met 6:192 BW.

I ATTENZIONE

La garanzia ed eventuali risarcimenti di qualsiasi tipo saranno applicabili solo in caso di montaggio corretto, conforme alle istruzioni ed effettuato all'interno di un'officina autorizzata. Un montaggio effettuato in modo improprio o in un posto diverso da un'officina autorizzata renderà nulla qualsiasi richiesta di risarcimento, di qualsiasi tipo, in particolare quelle che si appellano alla responsabilità del fabbricante per difetti del prodotto. Il modello N.: 0553005

è progettato per il veicolo suddetto e può essere montato solo su tale veicolo. Per il fissaggio, utilizzare esclusivamente i componenti forniti.

Il Produttore declina qualsiasi responsabilità per danni o lesioni derivanti dall'impiego di queste parti/accessori, ad eccezione della responsabilità per difetti del prodotto, come indicato nel Codice Civile Olandese negli articoli dal 6:185 fino al 6:192 incluso.

Required tools / Benötigte Werkzeuge / Benodigde werktuigen

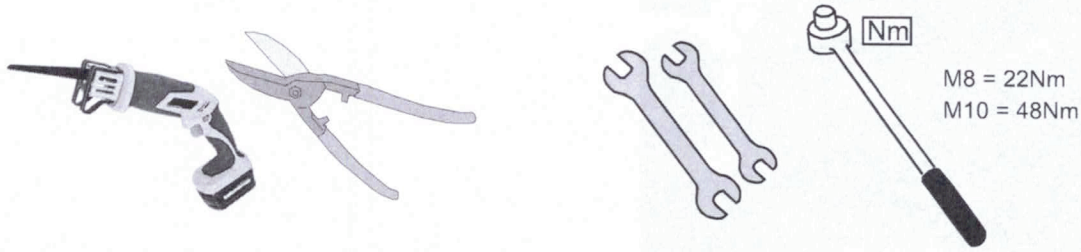

Parts list / Stückliste / Onderdelenlijst

CLEANING

MONTAGE

A

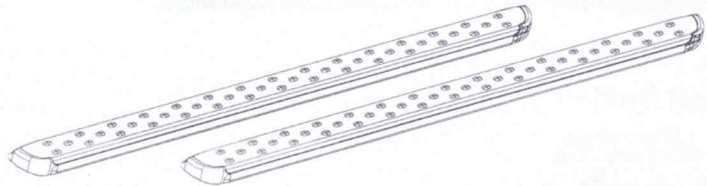

B

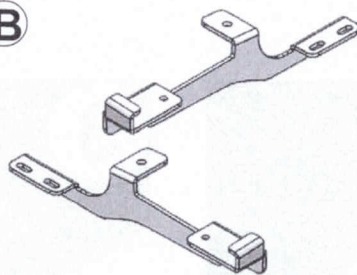

C

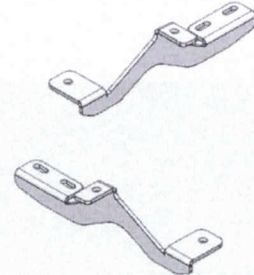

D

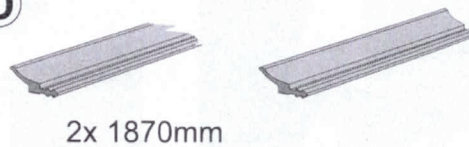

| | | | |
|----------------------|-----------------------|---------------|---------------|
| 8x M8 x 20 | 2x M8 x 25 | 10x M8 | 10x M8 |
| 6x M10 x 30 | 6x M10 | 6x M10 | |
| 2x M8 15X40X6 | 6x M10 20X50X8 | | |

left + right

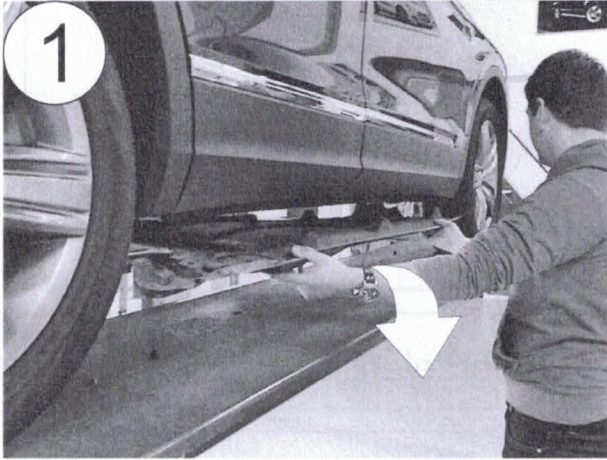

left front

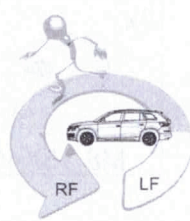
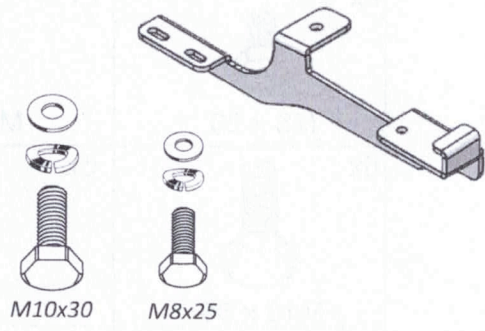
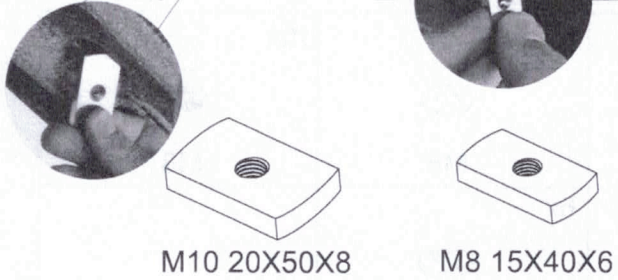
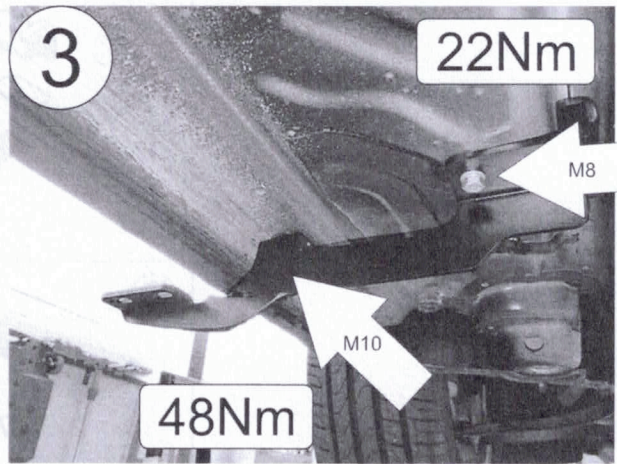
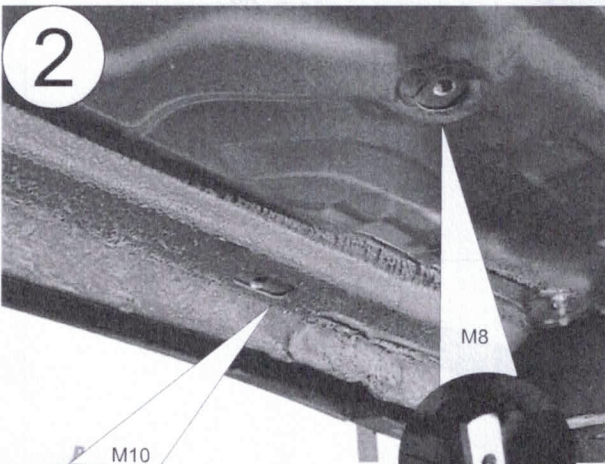
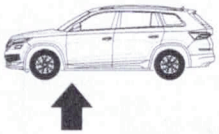

left rear

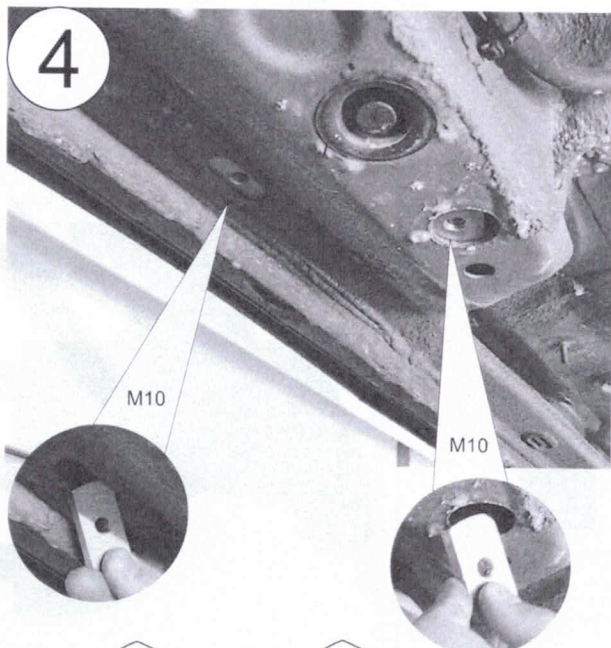

M10 20X50X8



M10 20X50X8



M10x30



M10x30

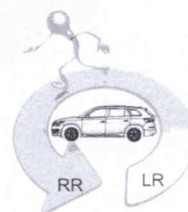
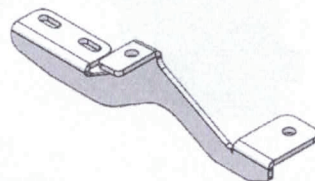

left + right

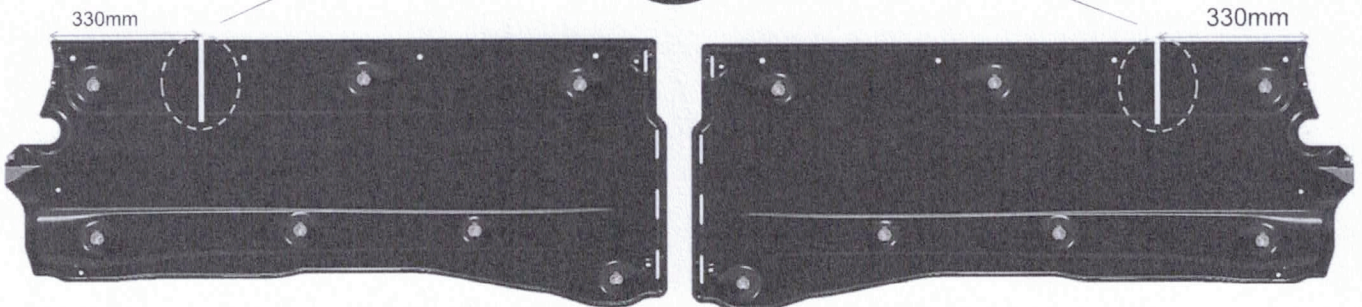
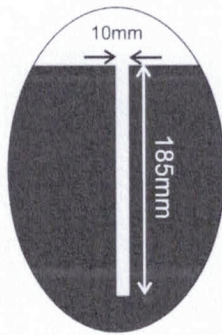
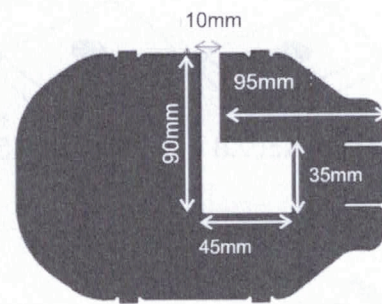
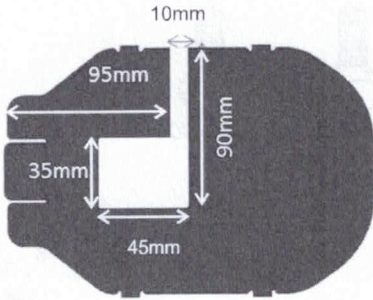
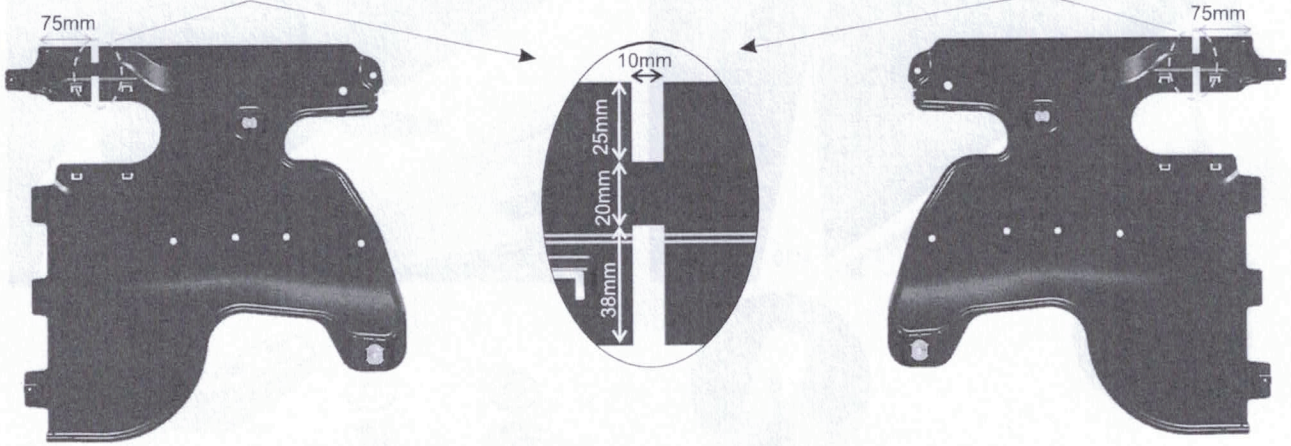

left + right

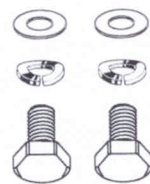
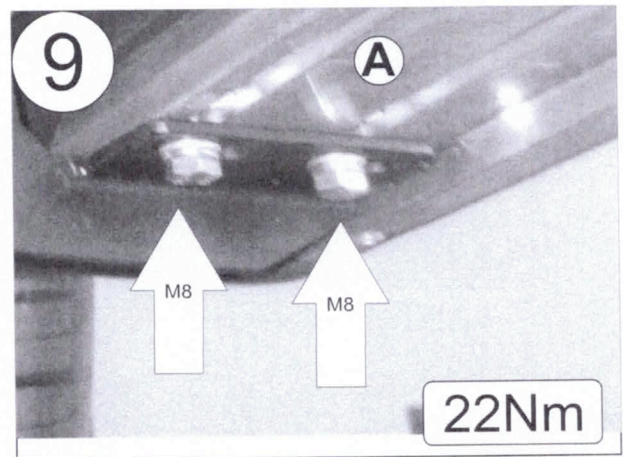
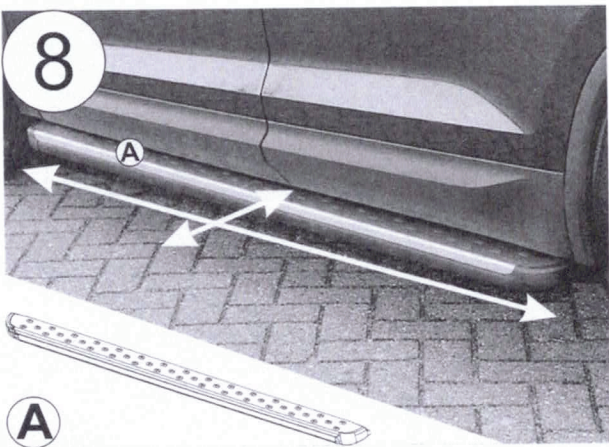
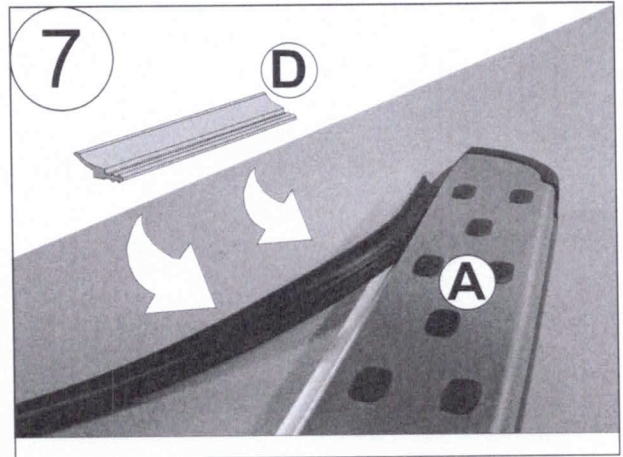
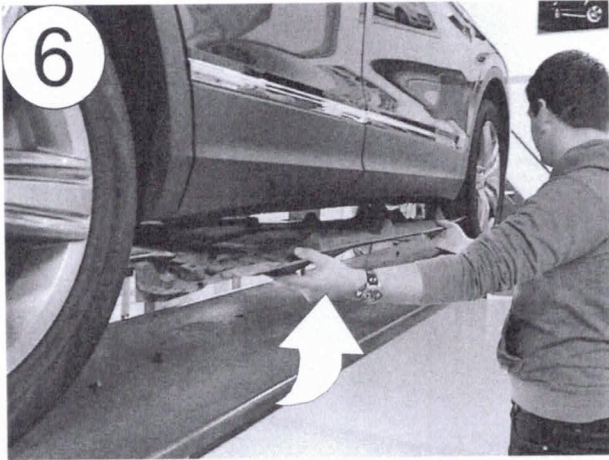

M8 x 20

